

# Assembly Instructions

## Venice Dining Table

- Before you begin to assemble your new piece of furniture, please check to ensure that all parts have been supplied.
- Follow instructions closely as deviation from them may void your warranty and present a possible safety risk.
- It is recommended that assembly is done on a soft surface like carpet to avoid any damage.
- If you experience any problems with your new purchase please phone our Customer Service Hotline 1800 807 416 (Customers outside Australia should contact their closest Freedom store.)

### Care Information

Periodically check and re-tighten any fasteners. Wipe down all surfaces weekly with a clean cloth. Do not clean any surfaces with harsh abrasives or chemicals.

### Hardware

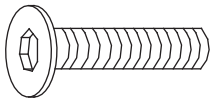

20xPartA

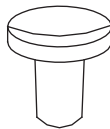

4xPart B

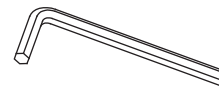

1xPartC

### Parts

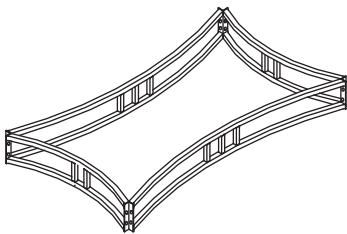

1xPart D

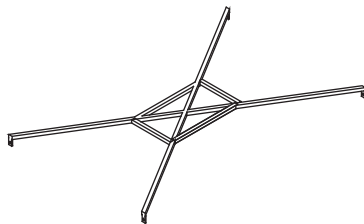

1xPart E

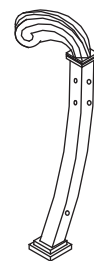

2xPart F

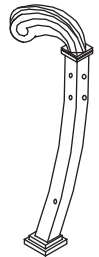

2xPart G

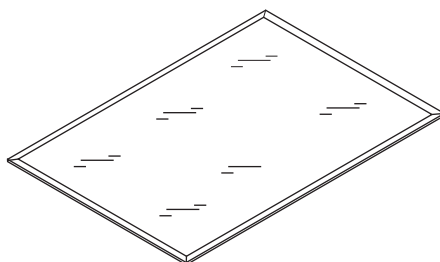

1xPart H

# Assembly Instructions

## Venice Dining Table

### Step: 1

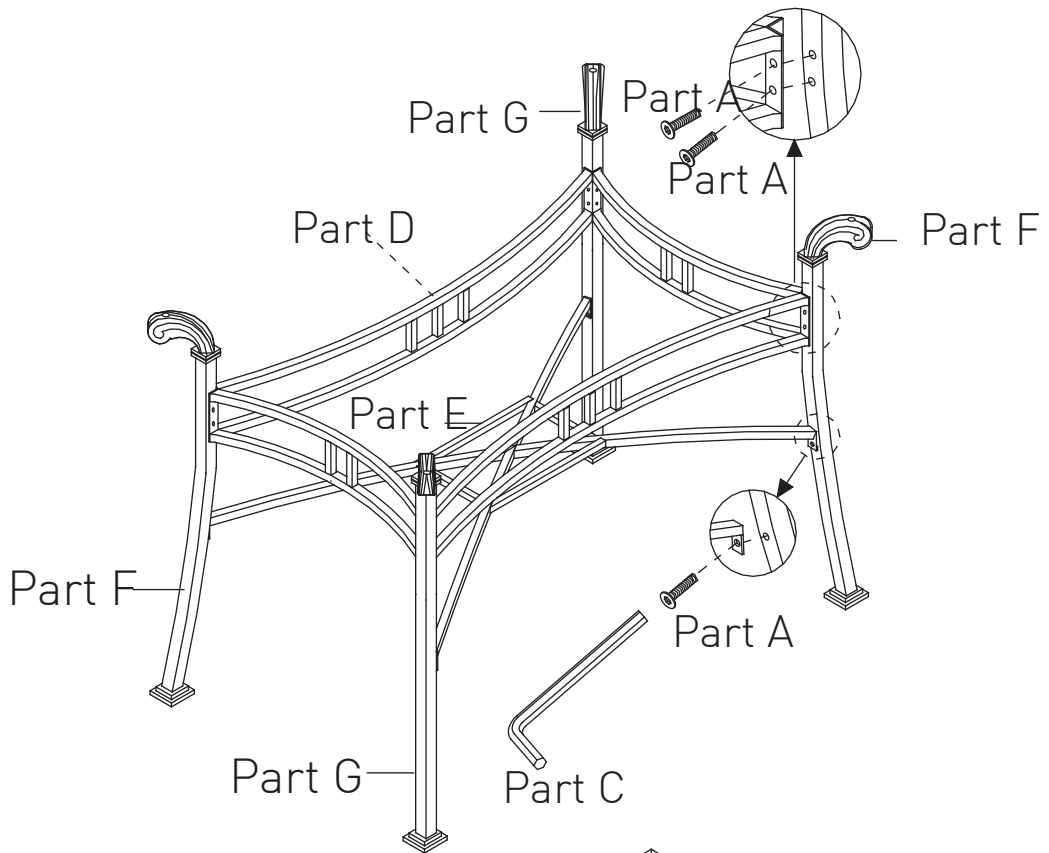

### Step: 2

