

Assembly Instructions

Venice Console Table

- Before you begin to assemble your new piece of furniture, please check to ensure that all parts have been supplied.
- Follow instructions closely as deviation from them may void your warranty and present a possible safety risk.
- It is recommended that assembly is done on a soft surface like carpet to avoid any damage.
- If you experience any problems with your new purchase please phone our Customer Service Hotline 1800 807 416 (Customers outside Australia should contact their closest Freedom store.)

Care Information

Periodically check and re-tighten any fasteners. Wipe down all surfaces weekly with a clean cloth. Do not clean any surfaces with harsh abrasives or chemicals.

Hardware

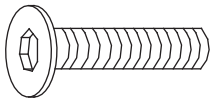

20xPartA

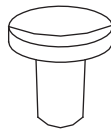

4xPart B

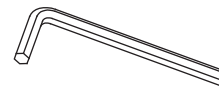

1xPartC

Parts

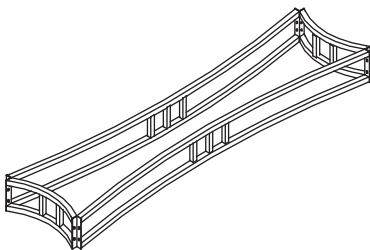

1xPart D

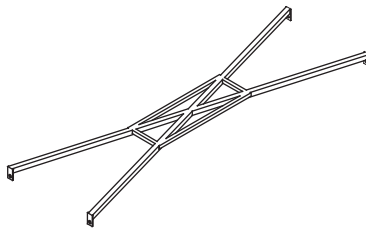

1xPart E



2xPart F

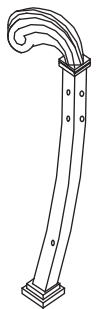

2xPart G

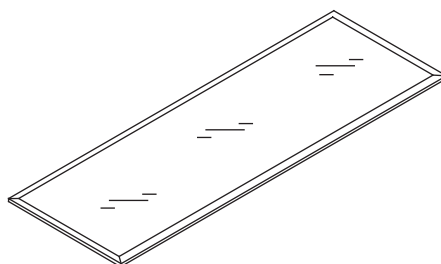

1xPart H

Assembly Instructions

Venice Console Table

Step: 1

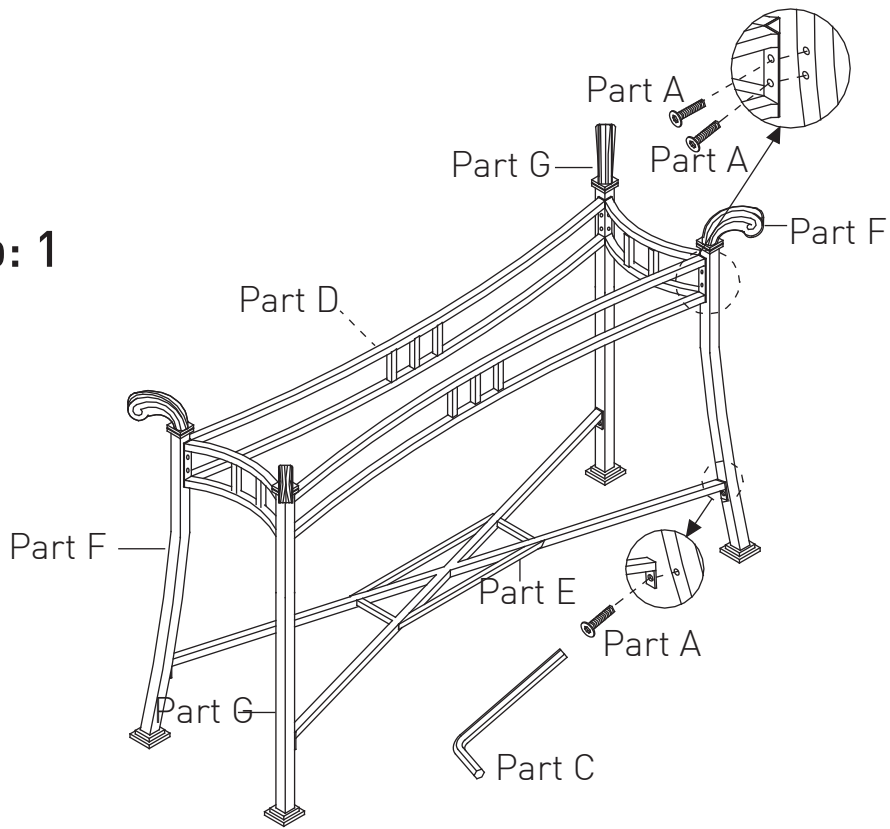

Step: 2

